

WORKSHOP DEALS

BAHCO



Podnośnik samochodowy

▶ Do 50 % szybsze podnoszenie



Film instruktażowy z obsługi i konserwacji

BH11500 1,5 ton

1027,70 PLN



BH12000 2 tony

898,70 PLN



BH13000 3 tony

941,70 PLN



BH1CB1000 Belka poprzeczna



BH1A2500

Aluminiowy podnośnik samochodowy 2,5 ton

▶ podwójny tłok umożliwia uzyskanie maksymalnej wysokości przy 6 ruchach pompy



BH4S- Podnośnik samochodowy butelkowy



-20°C - +70°C

BAHCO	T	mm	mm	kg	PLN
BH4S2	2	181	345	2,2	85,79
BH4S4	4	194	372	3,4	98,69
BH4S6	6	216	413	5,0	128,79
BH4S8	8	230	457	5,7	150,29
BH4S12	12	230	465	7,8	214,79

BH33000

Podstawki, 3 tony

▶ trzpień bezpieczeństwa

171,79 PLN

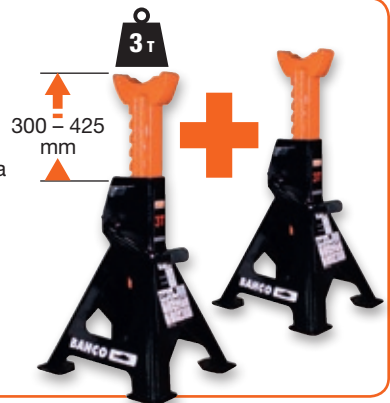

System modułowy Bahco Fit&Go

Amortyzator przy każdej szufladzie

Powierzchnia robocza z tworzywa sztucznego z przegródkami na małe części,
• opcjonalnie: drewno, płyta MDF, stal szlachetna

Stabilna konstrukcja

- ▶ Wzmocniona dwucienna rama
- ▶ Zaokrąglone krawędzie
- ▶ Lakier odporny na zadrapania
- ▶ Całkowicie wysuwające się szuflady

3564,70 PLN

Master Key
PIN
opcjonalnie

Ø125 x 36 mm

Lock&Go

1477K7BKFF14SD
PREMIUM LINE
Wózek warsztatowy wraz z narzędziami

NOWOŚĆ

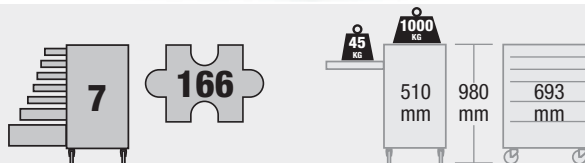

Pobranie danych dotyczących produktu w formacie PDF

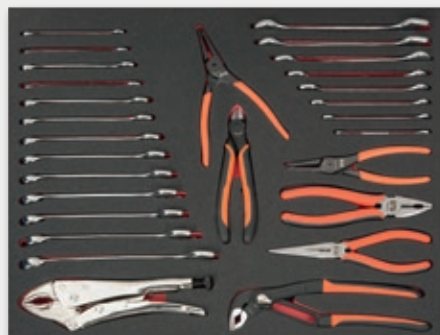

28 543 x 445 mm



23 543 x 445 mm



115 543 x 445 mm

DO LOTERII

DOBRE WYPOSAŻENIE DZIĘKI NASZYM PROMOCJOM STORAGE DEALS

Wygraj Golden Ticket kupując w ramach jednej z naszych promocji Storage Deals

Oferta Bahco obejmuje produkty związane z narzędziami, poczynając od przenośnych toreb na narzędzia aż po wózki narzędziowe do warsztatów z pełnym asortymentem narzędzi obejmującym 245 części – wszystko, czego potrzebujesz do bezpiecznego i wygodnego przechowywania. Warto zaoszczędzić, a przy odrobinie szczęścia można się znaleźć w gronie zwycięzców, którzy w naszych produktach znaleźli jeden z 10 Golden Tickets dla dwóch osób.

Twoja szansa na wygranie wycieczki na słynny hiszpański tor wyścigowy w Madrycie:
Wyślij do nas swoje zamówienie na jeden z produktów objętych naszą promocją Storage Deals lub zarejestruj się do loterii online.



gumowa mata



System modułowy Bahco Fit&Go

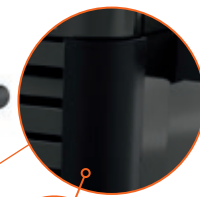

Zabezpieczone krawędzie boczne



Standardowe kolory

Stabilna konstrukcja

- ▶ Wzmocniona dwuścienna rama
- ▶ Całkowicie wysuwające się szuflady

2403,70 PLN



Ø125 x 36 mm



Master Key

> 200 kodów

1472K6BKFF7SD

Wózek warsztatowy wraz z narzędziami



Lock&Go

NOWOŚĆ

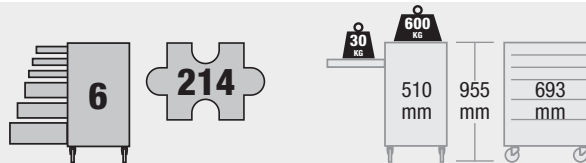

Pobranie danych dotyczących produktu w formacie PDF



31 543 x 445 mm



25 543 x 445 mm



158 543 x 445 mm

Bahco Fit&Go Kompatybilne moduły na narzędzia

1/3

181 x 445 mm
48 zestawów



2/3

362 x 445 mm
25 zestawów

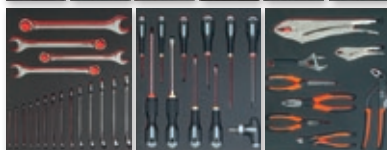

3/3

543 x 445 mm
28 zestawów

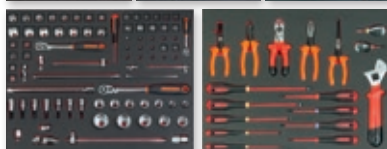

Akcesoria opcjonalne



Akcesoria PREMIUM LINE opcjonalnie

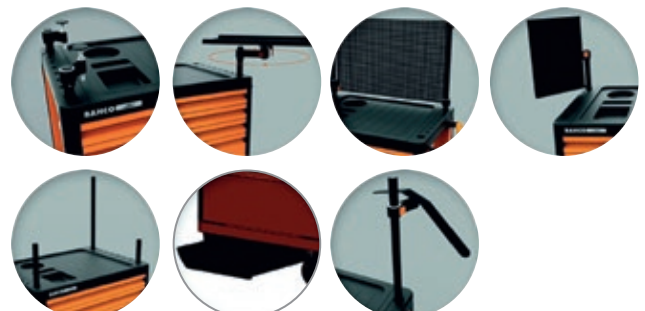

BH6FC1000
Składany żuraw
podnośny,
1 tona

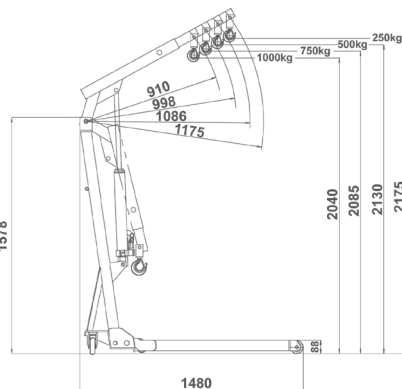
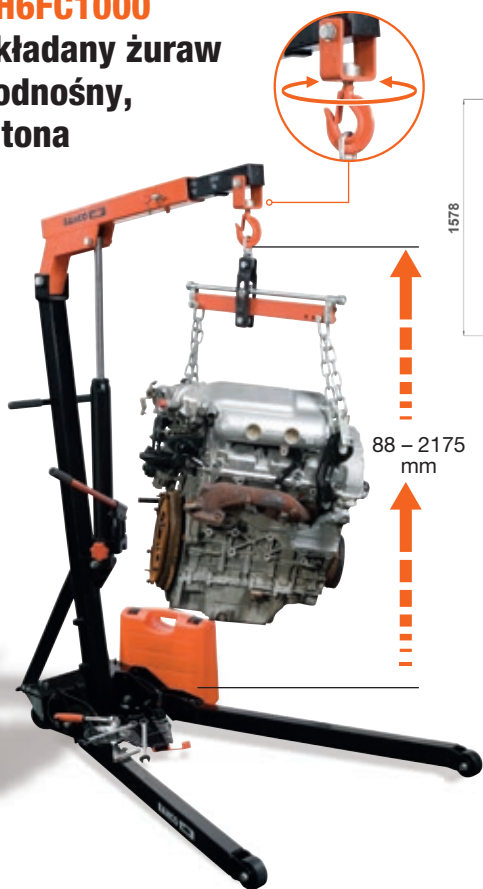

- ▶ Podwójny tłok umożliwia nawet o 50 % szybsze podnoszenie
- ▶ Czuwak
- ▶ Zawór przeciążeniowy



BH720
Prasa hydrauliczna
20 ton

5155,70 PLN

- ▶ Wciągarka z wychylnym uchwytem umożliwiającą wygodne przemieszczanie stołu prasy
- ▶ Mocna spawana rama i stabilne nogi

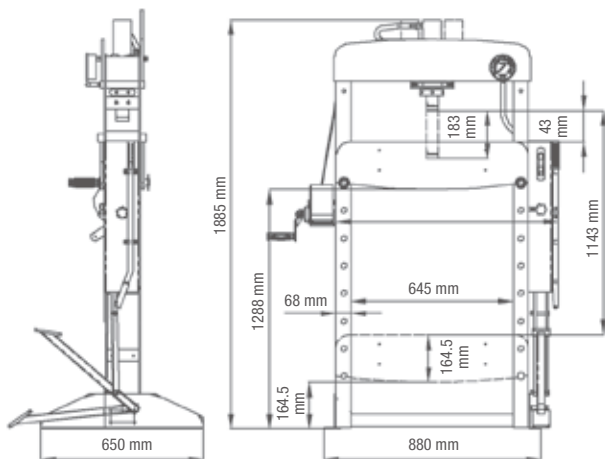

Film instruktażowy z obsługi i konserwacji

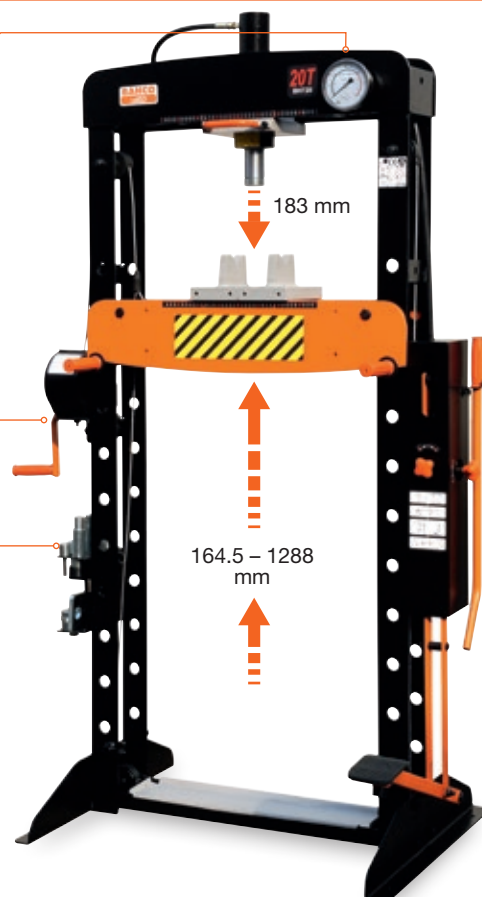

BLE300
Stół warsztatowy z szufladami



429,79 PLN

BLE301 Leżanka na kółkach



214,79 PLN

BLE305
Taboret obrotowy



263,78 PLN

BLE304

Leżanka na kółkach i fotel roboczy w zestawie

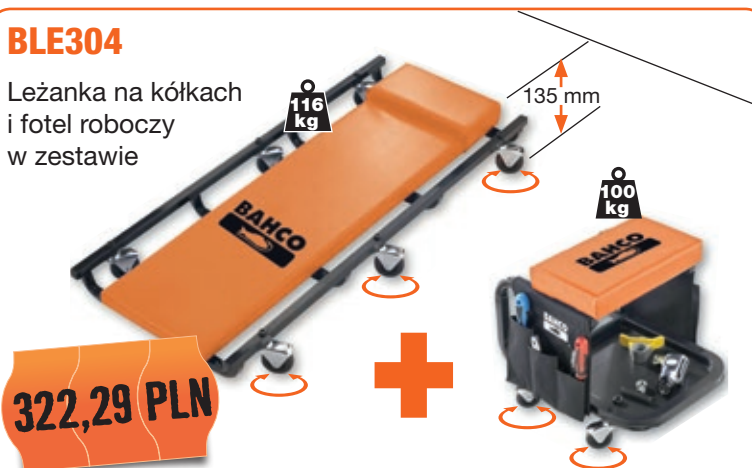

322,29 PLN

1470KC3
Wózek na kółkach

515,79 PLN



Elastyczne podnośniki magnetyczne



BAHCO			PLN
B147.001.400	1 kg	10 mm	55,69
B147.003.400	3 kg	13 mm	62,35

1419-MD

Miska magnetyczna
Ø 150 mm

27,95 PLN



BMD150

Miska magnetyczna
Ø 150 mm

29,89 PLN



2509 Giętki chwytak

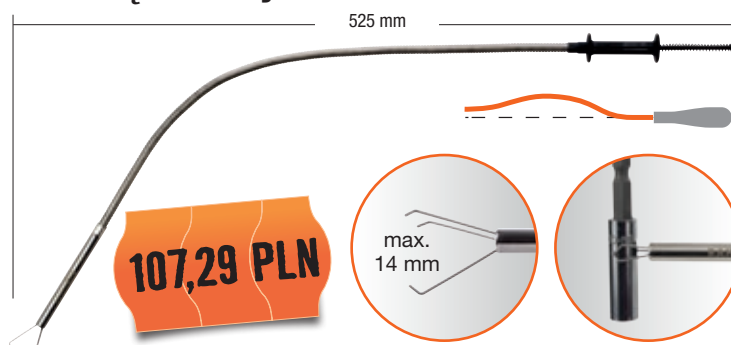

107,29 PLN

W pełni zautomatyzowany ośmiostopniowy cykl ładowania

Krótsza trwałość baterii może mieć różne powody:

- ▶ Zasiarczenie: powstają, gdy bateria nie jest wystarczająco naładowana
- ▶ osadzanie się warstw kwasu: w przypadku mocno rozładowanej baterii
- ▶ wysuszenie: występuje w przypadku niebezpiecznego przeładowania w wyniku 'parowania' płynu znajdującego się w baterii.

Systematyczna pielęgnacja i ładowanie zapobiegają przedwczesnemu zepsuciu baterii, zapewniają zawsze pełną moc baterii i wydłużają jej trwałość.



Ośmiostopniowy cykl ładowania nie tylko zwiększa efektywność ładowania baterii lecz zapewnia także prawidłowy przebieg procesu ładowania, zapewniając dłuższą trwałość baterii.



1. Analiza baterii
2. Naprawienie baterii (En)
3. Łagodny start
4. Tryb Bulk
5. Absorpcja
6. Monitorowanie
7. Tryb Float
8. Tryb doładowania



w 100% sterowany automatycznie & mikroprocesorem



BBCE612-2

W pełni automatyczny mikroprocesor, urządzenie do ładowania i doładowywania baterii, **2 amper**, ośmiostopniowe

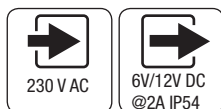

BBCE12-6

W pełni automatyczny mikroprocesor, urządzenie do ładowania i doładowywania baterii, **6 amper**, ośmiostopniowe

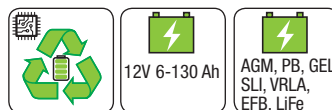

BBL12-400

Akumulator litowo-jonowy 12V

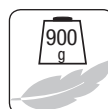
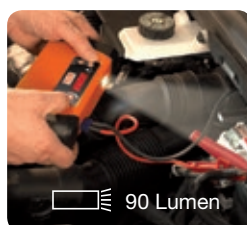
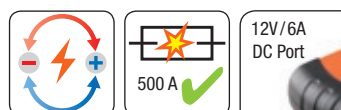
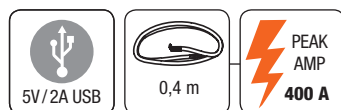
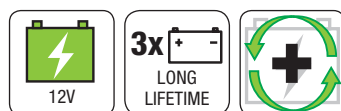

Film instruktażowy z obsługi i konserwacji

90 Lumen



BBH12-1200

Hybrid booster 12 V 1200 CA

- ▶ Rezerwowa bateria litowa uruchamia także pojazdy z rozładowanym akumulatorem
- ▶ 3 możliwości prostego i szybkiego naładowania ultrakondensatorów
 1. przy pomocy rozładowanych baterii za pośrednictwem zacisków (60-120 sekund)
 2. przy pomocy łącza 12V DC, zapalniczka żarowa (4-6 minut)
 3. przy pomocy zintegrowanej rezerwowej baterii litowej (4-6 minut)
- ▶ Tryb przejściowy do uruchomienia pojazdów z rozładowaną baterią lub bez baterii

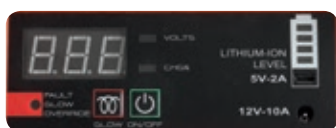
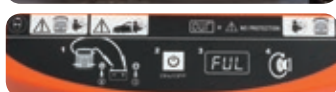

1811,01 PLN



Film instruktażowy z obsługi i konserwacji

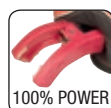
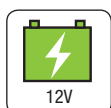

BBA1224-1700

Booster 12 / 24 V
1.700 / 900 CA

- ▶ Przełącznik szybkiego wyboru napięcia
- ▶ Elektroniczna kontrola bezpiecznika
- ▶ Automatyczna elektroniczna ładowarka z 3 kolorowymi lampkami LED
- ▶ Opcjonalnie dostępny kabel do zapalniczki 12V BBSNL4FX001



Łącze 12 V z wewnętrznym bezpiecznikiem 16 A do obsługi małych urządzeń

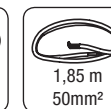
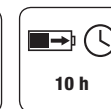
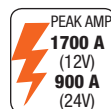
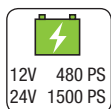

30 kg

2551,78 PLN

BELMS120BDL

Wbudowana płytki (OBD-L)

- ▶ OBD-L automatycznie wykrywa, czy przepływ jest aktualny i czyni go dostępnym do danych w sposób kontrolowany
- ▶ Łatwa 3-stopniowa obsługa

Idealny do boosterów

- BBL12-400
- BBL12-800
- BBA12-1200
- BBA1124-1700



194,09 PLN



BB1200A

Akumulator zapasowy do boosteru 12 V (24 Ah)

- ▶ 336 W

Do stosowania z boosterem:

- BBA12-1200
- BBA1224-1700
- BB12-1200
- BB1224-1200
- BB24-1200
- ZB12-1200
- ZB1224-1200
- ZB24-1200

558,79 PLN



9,6 kg



59/S54BC

54

Zestaw narzędzi

● 1/4" DIN 3126-C6.3, ISO 1173

NOWOŚĆ



<25mm>							<125mm>	<150mm>
⊖	⊕	⊕	⊕	⊕	⊕	⊖	⊕	⊕
4.5	PH1	PZ1	T10 x2	TR10	HEX3	R1	PH1	T20
5.5	PH2 x4	PZ2 x4	T15 x2	TR15	HEX4	R2	PH2	T25
	PH3	PZ3	T20 x4	TR20	HEX5			T30
	PH2G x2		T25 x2	TR25	HEX6		⊕	
			T27	TR30	HEX8		PZ1	
			T30 x4				PZ2	
			T40					

85,79 PLN

COLOURED

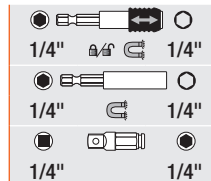
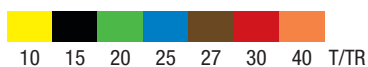

59/S100BC

100

Zestaw narzędzi

● 1/4" DIN 3126-C6.3, ISO 1173

NOWOŚĆ



<25mm>						
⊖	⊕	⊕	⊕	⊕	⊕	⊖
4.5	PH1	PZ1 x2	T10 x3	TR10	HEX3	R1
5.5	PH2 x9	PZ2 x9	T15 x5	TR15	HEX4 x3	R2
	PH3	PZ3	T20 x15	TR20	HEX5	
	PH2G x5		T25 x8	TR25	HEX6 x3	
			T27	TR30	HEX8	
			T30 x15			
			T40 x3			

105,38 PLN

COLOURED

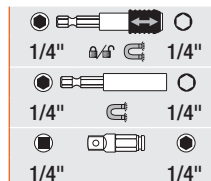
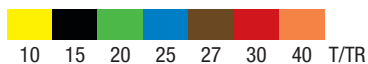

59/S31B

● 1/4" DIN 3126-C6.3, ISO 1173

31

Zestaw narzędzi

31,75 PLN



⊖	⊕	⊕	⊕	⊕
4.5	PH1	PZ1	T10	HEX3
5.5	PH2 x3	PZ2 x3	T15 x3	HEX4
	PH3	PZ3	T20 x3	HEX5
	PH2G x2		T25 x2	HEX6
			T27	
			T30	



BE5049T

Zestaw narzędzi,
● 10 mm

279,29 PLN



49

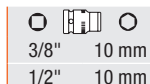

B705.1/4.125

Uchwyt do narzędzi

○ 1/4" E 6.3



32,80 PLN



<30mm>			<70mm>			<200mm>
⊕	⊕	⊕	⊕	⊕	⊕	⊕
HEX4	XZN5	T20	HEX4	XZN5	T20	T30
HEX5	XZN6	T25	HEX5	XZN6	T25	T40
HEX6	XZN8	T27	HEX6	XZN8	T27	T45
HEX6	XZN10	T30	HEX6	XZN10	T30	
HEX8	XZN12	T40	HEX8	XZN12	T40	<100mm>
HEX10		T45	HEX10		T45	⊕
HEX12		T50	HEX12		T50	T70
		T55			T55	T80
		T60			T60	

BAHCO **Fit** B219.005



42,79 PLN

Zestaw wkrętek

- ⊖ 0.5x3.0x75
0.8x4.0x100
1.0x5.5x125

- ⊕ PH1 x100
PH2 x125



BAHCO **Fit** B219.025



59,99 PLN

Zestaw wkrętek TORX®

- ⊕ T10x75
T15x100
T20x100
T25x125
T30x150



BAHCO **Fit** Wkrętek, ekstra długi

B191.040.250

- ⊖ 0.8 x 4.0 x 250 mm

250 mm

19,35 PLN

B191.055.300

- ⊖ 1.0 x 5.5 x 300 mm

300 mm

21,29 PLN

B192.001.250

- ⊕ PH1 x 250 mm

250 mm

20,43 PLN

B192.002.300

- ⊕ PH2 x 300 mm

300 mm

22,58 PLN



BE-9881TB



130,88 PLN

Zestaw wkrętek ERGO™
do pobijania



NOWOŚĆ



- 0.6x3.5x75
0.8x4.5x100
1.0x5.5x100
1.2x6.5x125



- PH1 x100
PH2 x125



Klucze ERGO™



Maksymalny komfort dzięki ergonomicznemu designowi

272 mm

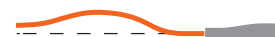

BAHCO	Hex	PLN
BE-7606	Hex 6	42,79
BE-7607	Hex 7	47,09
BE-7608	Hex 8	51,39



BPC815 Wkrętak udarowy 1/2"



580,29 PLN

max. 1112 Nm



	BAR							
1/2"	6.3	10 mm	113 1/min	786 Nm	1.112 Nm	8.000 min-1	88 dba	1,91 kg



Video návody k použití & údržbě



BP500
Uchyt magnetický

81,49 PLN

BWSMB17

Klucz nasadowo udarowy

- ▶ 1/2"
- ▶ Zewnętrzna warstwa z tworzywa sztucznego



85 mm
34,31 PLN

- ▶ Maybach, Mercedes C (W204), CL (W216), GLK (W204), E (W207, W211, W212), M-GLC(W166), ML (W164, W166), S (W221, W222), SLK (W172)

BWSMB15

Klucz nasadowo udarowy

- ▶ 1/2"
- ▶ Zewnętrzna warstwa z tworzywa sztucznego
- ▶ Smart, Citroën, etc.

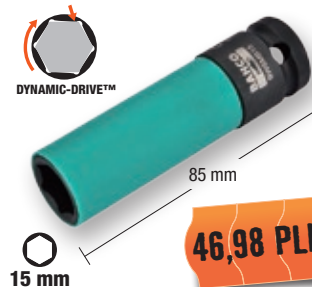

15 mm

46,98 PLN

BWSS12P3

Zestaw kluczy nasadowych

- ▶ 1/2"
- ▶ Zewnętrzna osłona z tworzywa sztucznego



77,19 PLN

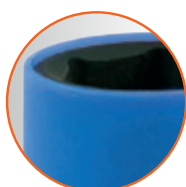

17 mm

19 mm

21 mm

3625PU-

Młotki z zabezpieczeniem przeci-wodrzutowym

NOWOŚĆ



PU

83-86 Shore A

-20°C - +90°C

BAHCO	mm	mm	g	PLN
3625PU-30	300	35	300	55,69
3625PU-50	340	50	640	85,79
3625PU-60	400	60	1080	128,79

7445- Mechaniczny klucz dynamometryczny ze skalą pomiarową

NOWOŚĆ



▶ ISO 6789 $\pm 4\%$

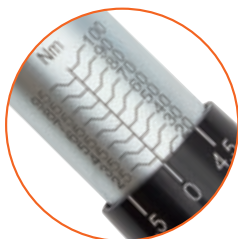
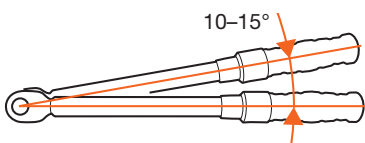

BAHCO	mm	Nm	mm	g	PLN
7445-100	3/8"	20-100	395	960	580,38
7445-100A	1/2"	20-100	395	970	545,18
7445-200	1/2"	40-200	466	1252	619,78
7445-340	1/2"	60-340	615	1500	686,66

2484/S4

Zestaw łomów

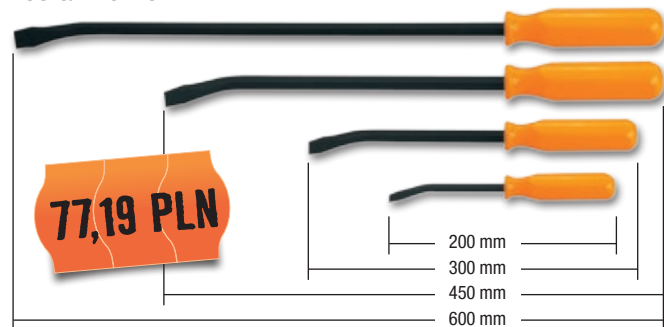

77,19 PLN



38-

Podnośnik opon

BAHCO	mm	PLN
38-12	300	53,75
38-16	400	59,99
38-20	500	72,89
38-24	600	85,79



170 mm

BLTS7P

Latarka podwójna

85,79 PLN



7 SMD LED



45 Lumen



4



IP20



USB



BLTS10

Latarka ze zmienną ogniskową

107,29 PLN



10 SMD LED



180 Lumen



4



IP20



USB



1200 mAh-s Li-ion



KBSK-01

Nóż sportowy

42,79 PLN

75 mm



2444

Nóż uniwersalny

38,49 PLN

102 mm



KE18-01

Nóż malarski

ergo®

29,89 PLN

18 mm



2489

Skrobak

27,95 PLN

27 mm



782-U

Szczotka druciana

12,69 PLN

290 mm



WORKSHOP DEALS



BEITS-S7

Zestaw przegubowych kluczy nasadowych z uchwytem T

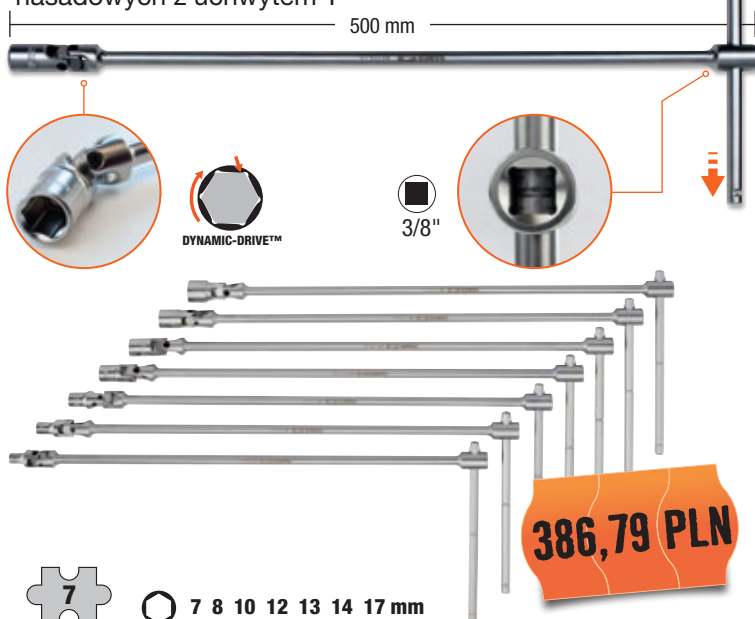

7 8 10 12 13 14 17 mm

111M/11T

Zestaw kluczy oczkowych

128,79 PLN



8 9 10 11 12 13 14 15 17 19 22 mm



www.bahco.com

JOIN THE BAHCO COMMUNITY

W Bahco World znajdziesz wiele ciekawych informacji o naszych produktach, targach, imprezach oraz o naszej firmie.



www.bahco.com/pl-pl/



Na naszych produktach marki Bahco znajdziesz wiele aplikacji z filmami instruktażowymi.

<https://www.youtube.com/user/ASCIBERIA>



SNA Europe

SNA Europe-Poland Sp. Z o.o.

Ul. Marynarska 15 · 02-674 Warszawa

Tel.: +48 607 05 10

Fax.: +48 607 05 21

Info.pl@snaeurope.com

Wszystkie dane i ilustracje prezentowane w niniejszej broszurze są niewiążące. Zastrzega się możliwość zmian. Podane ceny są cenami rekomendowanymi, do których należy doliczyć podatek VAT w ustawowej wysokości. Obowiązuje do 31.03.2018 lub do wyczerpania zapasów.